



10 DAY

2018 QUICKSHIP PROGRAM

SYSTEM 2

10 DAY / INTRODUCTION

Table of Contents

INTRODUCTION

Terms and Conditions	4
10 Day Standard Fabrics	6
10 Day Standard Finishes	7
Pull Options, 10-Day Quickship Storage	8

PANELS

Fabric-Covered Panel	
Non-Electrical	9
Electrical	11
Partial-Glazed Panel	
Non-Electrical	13
Electrical	14

PANEL HARDWARE

Draw Rods	15
Connectors	16

ELECTRICAL DISTRIBUTION

Electrical Distribution	18
-------------------------	----

WORKSURFACES

Square Edge Rectangular 24" Depth	20
Square Edge Rectangular 30" Depth	20
Square Edge Curved Corner	21
Square Edge Half Circle	21
Square Edge D-Shaped Peninsula	21
Square Edge Rectangular	22
Transaction Surface	22
Square Edge Corner	22
Transaction Surface	22

MY-HITE WORKSURFACES

Rectangular	23
Corner	24
D-Shaped	25

WORKSURFACE SUPPORTS

Flat Bracket	26
Worksurface Support End Panel	27
Worksurface Support P-Leg	27
Worksurface Bracket	27
Transaction Surface Support	
End	28
Mid-End	28
Center	28
Dual Column Leg	28
Column Leg	28

STORAGE

Overheads & Shelves	
"B" Style Shelf	
Half-Height	29
Full Height	29
"B" Style Locking Painted Flipper Unit	29
"B" Style Tackboard	30

COMPONENTS

LED Tasklight	31
Wire Manager	31
Pencil Drawer	31

PEDESTALS

Box/Box File Pedestal	32
File/File Pedestal	32
Box/Box/File Mobile Pedestal	33
Box/File Mobile Pedestal	33
File/File Mobile Pedestal	33
Side to Side File Bar	33

LATERAL FILES

2 Drawer Lateral Files	34
Front to Back File Bars	34
Lateral File Counterweight	34
Lateral File Tops	35
Pulls	
Lateral	36
Pedestal	37

ACCESSORIES

Tool Bars	38
Flat Paper Tray	38
Vertical Single Tray	38
Vertical Triple Tray	38
Carpet Gripper	38
Single Monitor Arm	39
Dual Monitor Arm	39

KEYED ALIKE

Keyed-Alike Locks	39
-------------------	----

Terms and Conditions

QUICKSHIP PROGRAM

Designed for complete workstation orders and parts may not be ordered separately. Orders with the Quickship program are limited to under 50 workstations. For larger orders, please contact your customer service representative for availability. 5 and 10 Day Quickship orders must be on separate P.O.s and cannot be combined with standard lead time orders.

PRICES

All Prices are list prices F.O.B. factory (Continental U.S.). We reserve the right to change prices without prior notice.

ORDERING

Purchase Orders should be sent to orders@friant.com or faxed to (510) 535-6895. If your specifications were created with CAP, GIZA or Project Matrix, please send the worksheet (SP4) with your Purchase Order.

TERMS

Net 30 days from date of invoice. Invoices are delinquent if not paid 30 days from date of invoice. In the event timely payment is not made, interest will be charged at the rate of 1.5% per month on delinquent accounts. Buyers will also be liable for normal collection costs and attorney's fee. 50% deposit is required with every order, unless prior arrangements have been made.

ORDERS

Orders are only accepted by issuance of our formal acknowledgment, and are subject to the terms set forth herein and on our order acknowledgment. It is the responsibility of the buyer to review our acknowledgment for its accuracy, and to notify Friant within 24 hours on 10 Day orders from the date of the acknowledgment of any discrepancies. No changes or cancellations can be made on 5 Day orders.

LEAD TIME

Lead times are subject to availability.

SHIPPING

Friant generally palletizes, boxes and/or shrink-wraps its products. If buyer requests additional packaging or special shipping, then it is responsible for any extra costs that result. Buyer obtains title to products and assumes the risk of loss for them upon shipment from Friant's plant.

CLAIMS

We are not responsible for damage suffered in transit. Merchandise should be inspected for possible freight damage upon delivery. The consignee should file for damage or shortages with the carrier within 5 days of delivery. You are also protected for "concealed damage" if you file claim with the carrier within 5 days of delivery. Buyer must make all claims against Friant for defects, errors or shortages in writing within 10 days after delivery. Failure to make such a claim shall constitute full acceptance.

RETURNS

No merchandise may be returned without our written consent and shipping instructions. Unauthorized returns will not be accepted and will be returned freight collect.

PARTIAL SHIPMENTS

We will make every attempt to ship orders complete and on schedule. However, we reserve the right to make partial shipments, as merchandise is ready. Invoices covering these shipments are to be paid as they become due.

ORDER CHANGE/CANCELLATIONS

There are no cancellations on 5 Day orders. Our order confirmation is final and binding. Any order change or cancellation is subject to our ability to conform. Such requests are to be made in writing to our office.

SHIPMENT AND PREPAID FREIGHT

Unless otherwise instructed, we reserve the option to ship by what is, in our opinion, the best possible way. Upon request, we will prepay and add freight for accounts with established credit.

DELIVERY

We are not liable for delay or failure of delivery due to strikes and/or differences with workmen, war, riot, fire, compliance with government regulations, acts of nature, failure or delays of sources of supply, or any other causes beyond our control.

Terms and Conditions continued

STORAGE

If buyer cannot accept delivery when merchandise is ready, we reserve the right to transfer goods to storage. Costs of transfer and storage will be charged to the buyer's account, and we will deem such transfer as constituting shipment for all purposes, including invoicing, as of the date the transfer is made.

CONSTRUCTION – SPECIFICATIONS

All items are produced to price list specifications unless otherwise advised. All dimensions shown are approximate. Manufacturer reserves the right to make modifications and/or improvements without prior notice.

FABRIC APPLICATION

Standard fabric application is horizontal. Friant & Associates is not responsible for charges associated with replacement of products due to incorrect specifications.

CUSTOMER'S OWN MATERIAL

Yardage requirement is based on 66" wide plain covering material, and must be increased if less than 66" wide. Special instructions for handling material (pattern, directional fabric, right side of reversible fabric, etc.) must be submitted in writing before fabric is delivered. In the absence of special instructions, we reserve the right to use our own judgment. We reserve the right to reject any covering, which in our opinion, is unsuitable for our upholstery purposes. However, in no instance shall we be held responsible for unsatisfactory results due to use of covering unsuitable for our upholstery methods.

We will not be responsible for errors caused by buyers not supplying us with sample cuttings attached to their order giving full identification of covering material, (name of supplier, covering name, number and color) for identification purposes and advising us of model number and quantity to which each cover is to be applied.

Customer's own material that is shipped freight collect will be refused. A service charge will be applied for the return of unusable C.O.M. Contact factory.

RIGHTS AND WARRANTIES – LIMITED LIFETIME WARRANTY

This warranty is given to the initial purchaser and is valid from the date of purchase, for as long as the initial purchaser owns the product. This warranty covers defects in material and craftsmanship found during normal usage of the product during the warranty period. If the product is defective, and if written notice of the defect is given to Friant & Associates within the applicable warranty period, Friant & Associates, at its option, will either repair or replace the defective product with a comparable component or product. This warranty applies to all products except as noted below.

High wear parts, such as wood veneer, fabrics, and other covering material/finishes, foam, glides, etc. are warranted for one (1) year. This warranty does not apply to damage caused by a carrier, alteration to the product not expressly authorized by Friant & Associates, nor to product considered to be of a consumable nature such as bulbs, light ballasts, etc. It also does not apply to "Customer's Own Material" (i.e. material specified by the customer that is not a standard Friant & Associates offering) used in the manufacture of Friant & Associates products.

Friant & Associates does not warrant the matching of colors, grain or texture, except to within commercially acceptable standards.

A product will not be considered defective, and Friant & Associates will not be obligated to replace it, if it is not installed in a proper manner (i.e. product not leveled, not secured properly, etc.).

Except as noted above, Friant & Associates makes no express or implied warranties to any product, and in particular makes no warranty of fitness for any particular use. At Friant & Associates' option, product repair and replacement is the customer's exclusive remedy for any and all product defects.

Friant & Associates shall not be liable for consequential, economic, or incidental damages arising from any product defect.

CALIFORNIA PROP 65 WARNING

Products in this catalog may contain a chemical known to the state of California to cause cancer, or birth defects or other reproductive harm.

10 Day Standard Fabrics

PASSAGE		TERRAIN		SLIDE	
PF601-1	Gull	PF701-1	Cloud	PF101-1	Caramel
PF601-2	Grove	PF701-2	Dusk	PF101-2	Slate
PF601-3	Wing	PF701-3	Wave	PF101-3	Pewter
PF601-4	Quartz	PF701-4	Earth	PF101-7	Java
PF601-5	Leaf			PF101-9	Sterling
PF601-6	Brook			PF101-10	Crema
PF601-7	Trail				
PF601-8	Amber				

* DISCONTINUED FABRICS FOR Q1

SLIDE

PF101-4	Verde
PF101-5	Twilight
PF101-6	Vintage
PF101-8	Latte
PF101-11	Breeze
PF101-12	Stem

*** Contact your Customer Service Representative for availability**

NOTE: Fabric direction as per Friant's fabric card only. Order fabric cards online at: www.friant.com/samples. All textiles listed above are 66" wide. Colors may vary slightly between dye lots. Additional fabrics are available for an upcharge. Contact our Design Department for pricing.

PF301-1	Terra	PF401-1	Natural	PF501-1	Smoke
PF301-2	Birch	PF401-2	Parids	PF501-2	Almond
PF301-3	Moss	PF401-3	Overcast	PF501-3	Sage
		PF401-4	Field	PF501-4	Straw
		PF401-5	Graphite		

10 Day Standard Finishes

Use the matrix below to see the complimentary finishes. **Please note**, M1-M13 have corresponding finishes, while M14-M29 are paired with exact matching finishes. For matching edge PVC, please read across matrix.

WORKSURFACE FINISHES		EDGE FINISHES (3MM PVC)		PAINT FINISH
M1	Light Maple	E1	Light Maple	DT Dark Tone MT Medium Tone CW Cloud White
M2	Light Cherry	E2	Light Cherry	
M3	Medium Cherry	E3	Medium Cherry	
M4	Dark Mahogany	E4	Dark Mahogany	
M6	Light Gray	E6	Light Gray	
M7	Off White	E7	Off White	
M9	Cloud White	E9	Cloud White	
M10	Espresso	E10	Espresso	
M11	Light Walnut	E14	Light Walnut	
M12	Medium Walnut	E15	Medium Walnut	
M13	Licorice	E13	Licorice	
M14	Carob	E17	Carob	
M16	Tundra	E19	Tundra	
M22	Harbor	E25	Harbor	
M23	Bark	E26	Bark	
M24	Tarmac	E27	Tarmac	
M25	Winter	E28	Winter	
M27	Medium Ash	E30	Medium Ash	
M28	Arctic	E31	Arctic	
Note: When pairing a laminate worksurface finish with hardsurface panel finish, there may be small difference. Contact your sales rep for details.		E8	Black Umber	
		E12	Dark Tone	

These are the standard laminates offered for hardsurface panels and laminate end panels (ending in -LAM).

Additional charge to use Hardsurface Panel Finishes on worksurfaces.

Note: Match edging to worksurface finish by NAME, not number, or submit order with Edge To Match (ETM).

10 DAY / INTRODUCTION

Order samples at www.friant.com/samples

Please Note: Images are printed simulations and are not exact matches of finished product. Please request an actual sample from Friant or your sales consultant before specifying finishes.

Pull Options, 10-Day Quickship Storage

You have multiple pull options. Please specify type when ordering. If you have any questions, please contact Friant Customer Service or your local sales rep.

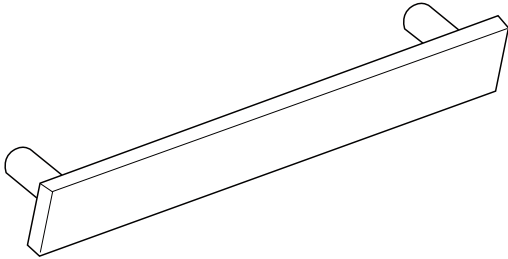

BAR PULL

(Standard Default)
Metal finish

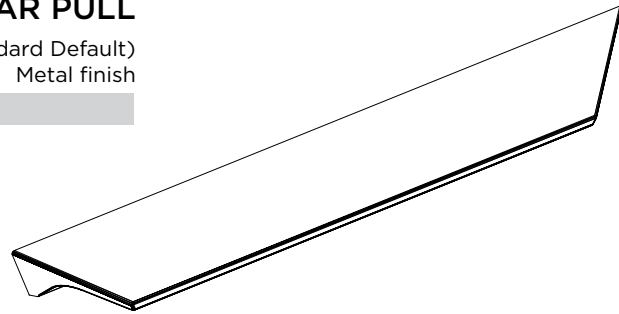

WEDGE PULL

Brushed metal finish
(Upcharge applies to metal storage. See page 36)

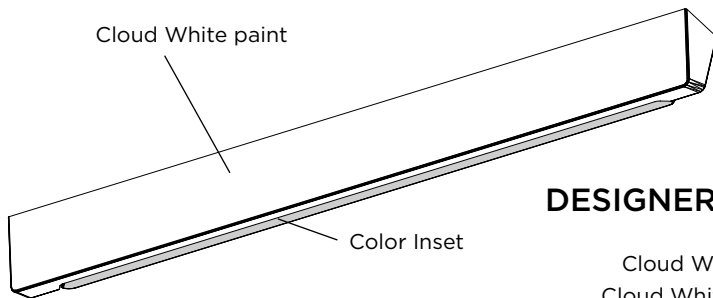

DESIGNER PULL

Cloud White/Red,
Cloud White/Green,
Cloud White/Grey

(Upcharge applies to metal storage. See page 36)

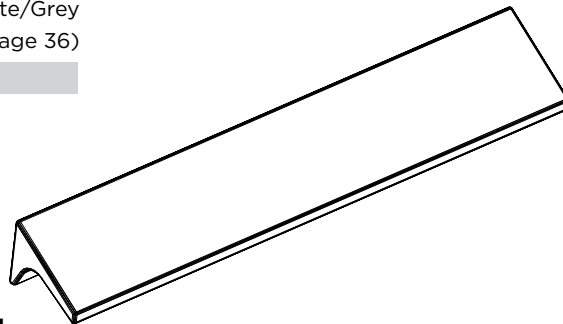

SLANT PULL

Brushed metal
(Upcharge applies to metal storage. See page 36)

10 DAY / INTRODUCTION

Fabric-Covered Panel Non-Electrical

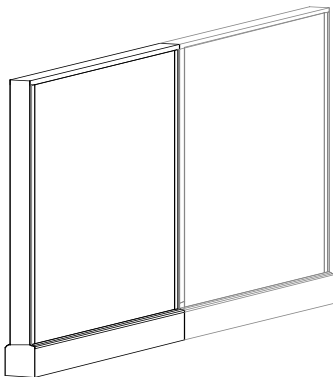

Structural panel with fabric surfaces, painted top caps and trim, leveling glides, and cable management side covers.

product #: see charts below
trim and top cap finish: LG Light Gray, MT Medium Tone, DT Dark Tone
base finish: MT Medium Tone, DT Dark Tone
fabric, side 1: see fabrics, page 6
fabric, side 2 (if applicable): see fabrics, page 6

- Order connectors and finished ends separately

product #: Q1F2FAPA.3924N
trim and top cap finish: DT Dark Tone
base finish: DT Dark Tone
fabric, side 1: PF101-1, Slide/Caramel
fabric, side 2 (if applicable): PF101-1, Slide/Pewter

39" HIGH

PART #	HEIGHT	WIDTH	DEPTH	WT. (LBS)	PRICE
Q1F2FAPA.3912N	39"	12"	3.5"	22	\$352
Q1F2FAPA.3918N	39"	18"	3.5"	24	\$374
Q1F2FAPA.3924N	39"	24"	3.5"	26	\$377
Q1F2FAPA.3930N	39"	30"	3.5"	27	\$414
Q1F2FAPA.3936N	39"	36"	3.5"	31	\$468
Q1F2FAPA.3942N	39"	42"	3.5"	36	\$494
Q1F2FAPA.3948N	39"	48"	3.5"	39	\$519
Q1F2FAPA.3960N	39"	60"	3.5"	46	\$643

47" HIGH

Q1F2FAPA.4712N	47"	12"	3.5"	25	\$373
Q1F2FAPA.4718N	47"	18"	3.5"	26	\$394
Q1F2FAPA.4724N	47"	24"	3.5"	29	\$400
Q1F2FAPA.4730N	47"	30"	3.5"	33	\$448
Q1F2FAPA.4736N	47"	36"	3.5"	38	\$513
Q1F2FAPA.4742N	47"	42"	3.5"	41	\$568
Q1F2FAPA.4748N	47"	48"	3.5"	47	\$586
Q1F2FAPA.4760N	47"	60"	3.5"	53	\$723

53" HIGH

PART #	HEIGHT	WIDTH	DEPTH	WT. (LBS)	PRICE
Q1F2FAPA.5312N	53"	12"	3.5"	26	\$381
Q1F2FAPA.5318N	53"	18"	3.5"	30	\$406
Q1F2FAPA.5324N	53"	24"	3.5"	32	\$409
Q1F2FAPA.5330N	53"	30"	3.5"	38	\$465
Q1F2FAPA.5336N	53"	36"	3.5"	41	\$544
Q1F2FAPA.5342N	53"	42"	3.5"	44	\$588
Q1F2FAPA.5348N	53"	48"	3.5"	51	\$627
Q1F2FAPA.5360N	53"	60"	3.5"	57	\$773

67" HIGH

PART #	HEIGHT	WIDTH	DEPTH	WT. (LBS)	PRICE
Q1F2FAPA.6712N	67"	12"	3.5"	30	\$407
Q1F2FAPA.6718N	67"	18"	3.5"	34	\$463
Q1F2FAPA.6724N	67"	24"	3.5"	40	\$476
Q1F2FAPA.6730N	67"	30"	3.5"	46	\$535
Q1F2FAPA.6736N	67"	36"	3.5"	51	\$620
Q1F2FAPA.6742N	67"	42"	3.5"	57	\$661
Q1F2FAPA.6748N	67"	48"	3.5"	64	\$704
Q1F2FAPA.6760N	67"	60"	3.5"	74	\$870

Fabric-Covered Panel Electrical

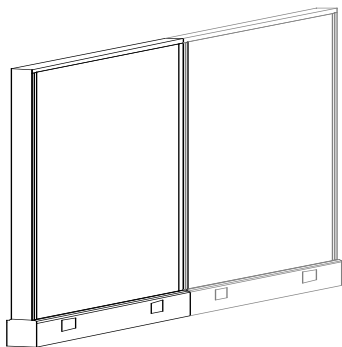

DESCRIPTION

Structural panel with fabric surfaces, painted top caps and trim, leveling glides, 4-circuit power installed and cable management side covers.

NOTES

- 12" and 18" wide panels have no receptacle.
- 24" wide panels have one receptacle per side.
- 30" - 60" wide panels have two receptacle locations per side.
- Order receptacles separately.
- Order connectors and finished ends separately.
- Order pass-through festoon separately.

SPECIFICATION OPTIONS

product #: see charts below
trim and top cap finish: LG Light Gray, MT Medium Tone, DT Dark Tone
base finish: MT Medium Tone, DT Dark Tone
fabric, side 1: see fabrics, page 6
fabric, side 2 (if applicable): see fabrics, page 6

ORDER EXAMPLE

product #: Q1F2FAPA.3924E
trim and top cap finish: DT Dark Tone
base finish: DT Dark Tone
fabric, side 1: PF101-1, Slide/Caramel
fabric, side 2 (if applicable): PF101-1, Slide/Pewter

39" HIGH

PART #	HEIGHT	WIDTH	DEPTH	WT. (LBS)	PRICE
Q1F2FAPA.3912E	39"	12"	3.5"	23	\$505
Q1F2FAPA.3918E	39"	18"	3.5"	25	\$519
Q1F2FAPA.3924E	39"	24"	3.5"	27	\$532
Q1F2FAPA.3930E	39"	30"	3.5"	29	\$567
Q1F2FAPA.3936E	39"	36"	3.5"	33	\$621
Q1F2FAPA.3942E	39"	42"	3.5"	38	\$647
Q1F2FAPA.3948E	39"	48"	3.5"	42	\$671
Q1F2FAPA.3960E	39"	60"	3.5"	51	\$796

47" HIGH

PART #	HEIGHT	WIDTH	DEPTH	WT. (LBS)	PRICE
Q1F2FAPA.4712E	47"	12"	3.5"	25	\$526
Q1F2FAPA.4718E	47"	18"	3.5"	27	\$541
Q1F2FAPA.4724E	47"	24"	3.5"	30	\$554
Q1F2FAPA.4730E	47"	30"	3.5"	35	\$601
Q1F2FAPA.4736E	47"	36"	3.5"	40	\$666
Q1F2FAPA.4742E	47"	42"	3.5"	43	\$722
Q1F2FAPA.4748E	47"	48"	3.5"	50	\$740
Q1F2FAPA.4760E	47"	60"	3.5"	58	\$876

53" HIGH

PART #	HEIGHT	WIDTH	DEPTH	WT. (LBS)	PRICE
Q1F2FAPA.5312E	53"	12"	3.5"	26	\$535
Q1F2FAPA.5318E	53"	18"	3.5"	30	\$549
Q1F2FAPA.5324E	53"	24"	3.5"	32	\$562
Q1F2FAPA.5330E	53"	30"	3.5"	38	\$619
Q1F2FAPA.5336E	53"	36"	3.5"	41	\$699
Q1F2FAPA.5342E	53"	42"	3.5"	44	\$742
Q1F2FAPA.5348E	53"	48"	3.5"	51	\$781
Q1F2FAPA.5360E	53"	60"	3.5"	57	\$927

67" HIGH

Q1F2FAPA.6712E	67"	12"	3.5"	31	\$560
Q1F2FAPA.6718E	67"	18"	3.5"	35	\$617
Q1F2FAPA.6724E	67"	24"	3.5"	41	\$629
Q1F2FAPA.6730E	67"	30"	3.5"	47	\$688
Q1F2FAPA.6736E	67"	36"	3.5"	53	\$773
Q1F2FAPA.6742E	67"	42"	3.5"	59	\$814
Q1F2FAPA.6748E	67"	48"	3.5"	67	\$857
Q1F2FAPA.6760E	67"	60"	3.5"	79	\$1,023

Partial-Glazed Panel Non-Electrical

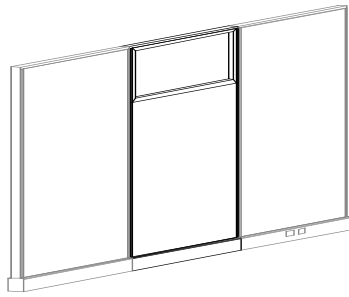

product #trim and top cap finishbase finish-
fabric, side 1fabric, side 2 (if applicable)

product #trim and top cap finishbase finish-
fabric, side 1fabric, side 2 (if applicable)

53" HIGH

Q1F2PGPA.5324N	53"	24"	3.5"	37	\$627
Q1F2PGPA.5330N	53"	30"	3.5"	41	\$683
Q1F2PGPA.5336N	53"	36"	3.5"	47	\$826
Q1F2PGPA.5342N	53"	42"	3.5"	54	\$869
Q1F2PGPA.5348N	53"	48"	3.5"	61	\$951
Q1F2PGPA.5360N	53"	60"	3.5"	73	\$1,097

67" HIGH

Q1F2PGPA.6724N	67"	24"	3.5"	42	\$694
Q1F2PGPA.6730N	67"	30"	3.5"	50	\$753
Q1F2PGPA.6736N	67"	36"	3.5"	56	\$900
Q1F2PGPA.6742N	67"	42"	3.5"	62	\$941
Q1F2PGPA.6748N	67"	48"	3.5"	71	\$1,029
Q1F2PGPA.6760N	67"	60"	3.5"	82	\$1,194

Partial-Glazed Panel Electrical

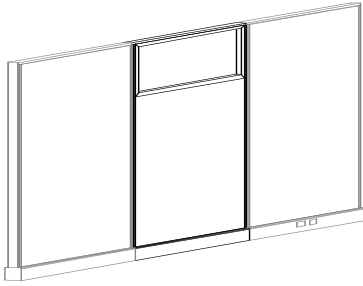

DESCRIPTION

Structural panel with fabric covered lower surfaces and 14" high-tempered clear glass top section, painted top cap and leveling glides, 4-circuit power installed in cable management raceway covers

NOTES

- 24" wide panels have one receptacle per side.
- 30" - 60" wide panels have two receptacle locations per side.
- Order receptacles separately.
- Order connectors and finished ends separately.
- Order pass-through festoon separately.

SPECIFICATION OPTIONS

product #: see charts below
trim and top cap finish: LG Light Gray, MT Medium Tone, DT Dark Tone
base finish: MT Medium Tone, DT Dark Tone
fabric, side 1: see fabrics, page 6
fabric, side 2 (if applicable): see fabrics, page 6

ORDER EXAMPLE

product #: Q1F2PGPA.5324E
trim and top cap finish: DT Dark Tone
base finish: DT Dark Tone
fabric, side 1: PF101-1, Slide/Caramel
fabric, side 2 (if applicable): PF101-1, Slide/Pewter

10 DAY PANELS

53" HIGH

PART #	HEIGHT	WIDTH	DEPTH	WT. (LBS)	PRICE
Q1F2PGPA.5324E	53"	24"	3.5"	38	\$781
Q1F2PGPA.5330E	53"	30"	3.5"	42	\$836
Q1F2PGPA.5336E	53"	36"	3.5"	49	\$978
Q1F2PGPA.5342E	53"	42"	3.5"	56	\$1,022
Q1F2PGPA.5348E	53"	48"	3.5"	63	\$1,104
Q1F2PGPA.5360E	53"	60"	3.5"	77	\$1,250

67" HIGH

PART #	HEIGHT	WIDTH	DEPTH	WT. (LBS)	PRICE
Q1F2PGPA.6724E	67"	24"	3.5"	43	\$848
Q1F2PGPA.6730E	67"	30"	3.5"	52	\$907
Q1F2PGPA.6736E	67"	36"	3.5"	57	\$1,054
Q1F2PGPA.6742E	67"	42"	3.5"	64	\$1,095
Q1F2PGPA.6748E	67"	48"	3.5"	74	\$1,182
Q1F2PGPA.6760E	67"	60"	3.5"	86	\$1,348

Draw Rods



DESCRIPTION

Panel hardware to connect two panels in a straight line.

NOTES

SPECIFICATION OPTIONS

product #: see charts below

ORDER EXAMPLE

product #: Q1FDR.34

DRAW ROD



PART #	HEIGHT	WIDTH	DEPTH	WT. (LBS)	LIST	NOTES
Q1FDR.34	34"	—	—	1	\$24	Rod and block assembly connects 2 panels at 180° (straight line). DT Dark Tone only.
Q1FDR.42	42"	—	—	1	\$24	
Q1FDR.48	48"	—	—	1	\$25	
Q1FDR.62	62"	—	—	1	\$25	

DRAW ROD CHANGE OF HEIGHT



Q1FDRCH.34	34"	—	—	1	\$38	Rod and block assembly connects 2 panels at 180° (straight line) when the panels are of different heights. Order the height of the shorter panel. Includes hanger rail to match the height of the shorter panel. Remove hanger rail from taller panel and replace with the shorter hanger rail Order change of height finished end separately. DT Dark Tone only.
Q1FDRCH.42	42"	—	—	1	\$38	
Q1FDRCH.48	48"	—	—	1	\$44	
Q1FDRCH.62	62"	—	—	1	\$44	

Connectors

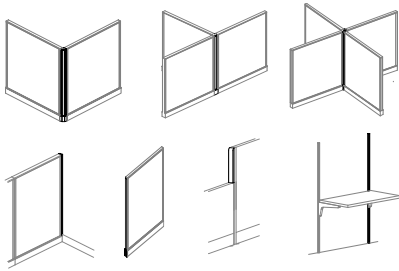

Panel hardware to connect panels.

product #: see charts below
finish: LG Light Gray, MT Medium Tone, DT Dark Tone
base finish: MT Medium Tone, DT Dark Tone

product #: Q1F22W.39
finish: DT Dark Tone
base finish: DT Dark Tone

2-WAY 90° CONNECTOR POST

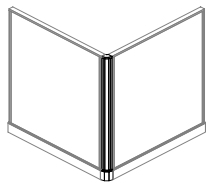

Q1F22W.39	39"	3.5"	3.5"	4	\$121
Q1F22W.47	47"	3.5"	3.5"	5	\$133
Q1F22W.53	53"	3.5"	3.5"	6	\$141
Q1F22W.67	67"	3.5"	3.5"	7	\$153

Connects 2 panels at 90°.

Includes cable management trim cover.

3-WAY 90° CONNECTOR POST

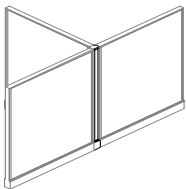

Q1F23W.39	39"	3.5"	3.5"	5	\$191
Q1F23W.47	47"	3.5"	3.5"	6	\$205
Q1F23W.53	53"	3.5"	3.5"	7	\$216
Q1F23W.67	67"	3.5"	3.5"	8	\$238

Connects 3 panels at 90°.

Includes cable management trim cover.

4-WAY 90° CONNECTOR POST

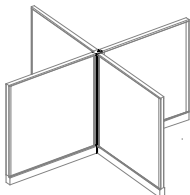

PART #	HEIGHT	WIDTH	DEPTH	WT. (LBS)	LIST
Q1F24W.39	39"	3.5"	3.5"	6	\$240
Q1F24W.47	47"	3.5"	3.5"	7	\$255
Q1F24W.53	53"	3.5"	3.5"	8	\$279
Q1F24W.67	67"	3.5"	3.5"	10	\$308

NOTES

Connects 4 panels at 90°.

FINISHED END



PART #	HEIGHT	WIDTH	DEPTH	WT. (LBS)	LIST
Q1F2FE.39	39"	3.5"	3.5"	2	\$56
Q1F2FE.47	47"	3.5"	3.5"	2	\$62
Q1F2FE.53	53"	3.5"	3.5"	2	\$62
Q1F2FE.67	67"	3.5"	3.5"	2	\$68

NOTES

Finishes the vertical end of a panel at the end of a panel run.

Includes cable management trim cover.

10 DAY / PANEL HARDWARE

Connectors continued

FINISHED END CHANGE OF HEIGHT

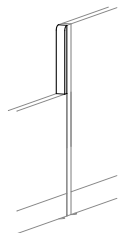

QIFFECH	48"	1.75"	0.25"	1	\$21
---------	-----	-------	-------	---	------

Finishes the exposed end if a panel or connector at a change of height location.

Includes finished end trim and mounting hardware.

May be cut to appropriate length.

WALL START

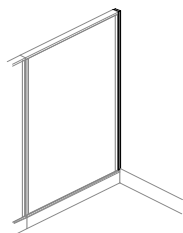

PART #	HEIGHT	WIDTH	DEPTH	WT. (LBS)	LIST
QIFWSTA.34	34"	1.75"	1"	2	\$60
QIFWSTA.42	42"	1.75"	1"	3	\$60
QIFWSTA.48	48"	1.75"	1"	3	\$60
QIFWSTA.62	62"	1.75"	1"	3	\$62

NOTES

Connects panel to structural wall or column.

Can also connect equal height panels at a 90° angle at any point along the panel width.

May be field cut to the appropriate length.

Order 1 additional draw rod of the same height.

WALL STRIP

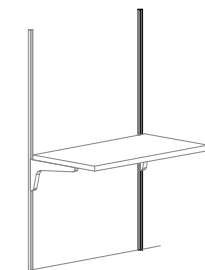

PART #	HEIGHT	WIDTH	DEPTH	WT. (LBS)	LIST
QIFWSST.60	60"	—	—	3	\$63
QIFWSST.72	72"	—	—	3	\$72
QIFWSST.84	84"	—	—	4	\$88

NOTES

Attaches to structural wall to hang worksurfaces and/or components.

Includes 1 wall strip.

Aluminum finish only.

Electrical Distribution

10 DAY / ELECTRICAL DISTRIBUTION

DESCRIPTION

Parts for distributing power through the system. Distributes up to four 20-amp circuits.

NOTES

- 4-circuit

SPECIFICATION OPTIONS

product #: see charts below
pole finish: MT Medium Tone, DT Dark Tone
base finish: MT Medium Tone, DT Dark Tone

ORDER EXAMPLE

product #: Q1F2CPE4.39
pole finish: DT Dark Tone
base finish: DT Dark Tone

BASE POWER ENTRY DIRECT CONNECT 4-CIRCUIT

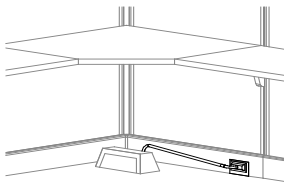

left angle elbow

Q1F2BPE	6'	5	\$327
---------	----	---	-------

Connects building power from a wall, floor or column to the base of a panel. Plugs directly into the panel's electrical harness at receptacle location.

Distributes up to four 20-amp circuits. Includes a cable that can be field-cut to the appropriate length.

MUST BE WIRED BY A LICENSED ELECTRICIAN.

CEILING POWER ENTRY INTERNAL DIRECT CONNECT 4-CIRCUIT

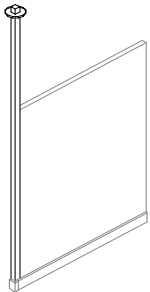

Q1F2CPE4.39	39"	3.5"	3.5"	13	\$659
Q1F2CPE4.47	47"	3.5"	3.5"	13	\$659
Q1F2CPE4.53	53"	3.5"	3.5"	13	\$659
Q1F2CPE4.67	67"	3.5"	3.5"	13	\$659

Connects a ceiling electrical supply to the base of a powered panel.

Distributes up to four 20-amp circuits.

Attaches to the end of a panel run, or to a 3 or 4-Way 90° connector.

To attach the power pole at the end of a panel run, order a draw rod separately.

To attach at a 2-Way connection, order a 3-Way connector.

To attach at a 3-Way connection, order a 4-Way connector.

Includes a rigid conduit and conduit connector, factory installed power harness, 12' pole, bezel, and end cap trim cover.

MUST BE WIRED BY A LICENSED ELECTRICIAN.

RECEPTACLE 4-CIRCUIT

Q1F2RECP.I	circuit A	0.25	\$27
Q1F2RECP.II	circuit B	0.25	\$27
Q1F2RECP.III	circuit C	0.25	\$27
Q1F2RECP.IIIII	circuit D, (dedicated)	0.25	\$27

Locks into panel base power harness.

Provides access to I, II, III or IIII circuit.

Provides dedicated circuit with "IIII" receptacle.

Electrical Distribution continued

CEILING DATA ENTRY INTERNAL DIRECT CONNECT NON-POWERED

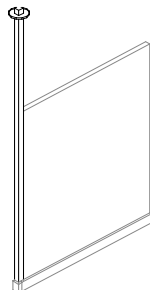

PART #	HEIGHT	WIDTH	DEPTH	WT. (LBS)	LIST
Q1F2CDE.39	39"	3.5"	3.5"	8	\$257
Q1F2CDE.47	47"	3.5"	3.5"	8	\$257
Q1F2CDE.53	53"	3.5"	3.5"	8	\$257
Q1F2CDE.67	67"	3.5"	3.5"	8	\$257

NOTES

Routes data/telecommunication cables from the ceiling to the base of a panel.

Attaches to the end of a panel run, to a 3 or 4-Way 90° connector.

To attach the power pole at the end of a panel run, order a draw rod separately.

To attach at a 2-Way connection point, order a 3-Way connector.

To attach at a 3-Way connection point order a 4-Way connector.

Includes a 12' pole, bezel and end cap trim cover.

PASS-THROUGH FESTOON 23" LONG 4-CIRCUIT

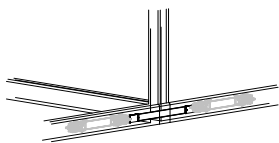

Q1F2CPK.1	23"			1	\$95
-----------	-----	--	--	---	------

Extends power when connecting power in a straight line through a 3 or 4-way connector post.

Extends power through a 120° or 135° 2 or 3 way connector.

DATA PORT PLATE

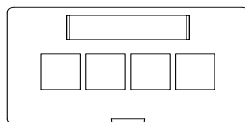

Q1F2DPP	2.125"	3.625"	0.250"	0.10	\$45
---------	--------	--------	--------	------	------

Used at the base of a panel to connect computers and/or communication equipment. It has 4 port locations and comes with 1 blank insert. Available in DT finish.

Worksurfaces

Worksurface hangs from a panel or Wall Strips. It has a laminate top and a PVC edge. There is a 1" gap at the back of the worksurface for plug and cord passage. 60" to 84" worksurfaces have a center support. Includes cantilever brackets, and attachment hardware.

product #: see charts below
top, edge finish: MT Medium Tone, DT Dark Tone
support finish: LG Light Gray, MT Medium Tone, DT Dark Tone
worksurface finish: see page 7

product #: Q1FSERWS.2424L
top, edge finish: DT Dark Tone
support finish: DT Dark Tone
worksurface finish: Light Maple

10 DAY WORKSURFACES

SQUARE EDGE RECTANGULAR 24" DEPTH

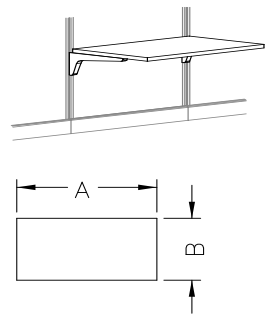

Q1FSERWS.2424L	1.25"	24"	24"	30	\$223
Q1FSERWS.2430L	1.25"	30"	24"	36	\$256
Q1FSERWS.2436L	1.25"	36"	24"	41	\$264
Q1FSERWS.2442L	1.25"	42"	24"	47	\$325
Q1FSERWS.2448L	1.25"	48"	24"	53	\$333
Q1FSERWS.2454L	1.25"	54"	24"	58	\$382
Q1FSERWS.2460L	1.25"	60"	24"	64	\$414
Q1FSERWS.2466L	1.25"	66"	24"	70	\$464
Q1FSERWS.2472L	1.25"	72"	24"	76	\$475

When ordering a worksurface spanning a panel and a 3-Way or Spacer Connector, or two panels with a 3-Way or Space Connector in between the panels, you will need to:

- add 3.5" to the length of the worksurface
- add "-3W" to the part number
- add \$80 to the list price.

Example:
 Two 30" frames with one 3-Way Connector equals to 63.5". In this case, order Q1FSERWS.2460L-3W. (\$414 + \$80 = \$494)

SQUARE EDGE RECTANGULAR 30" DEPTH

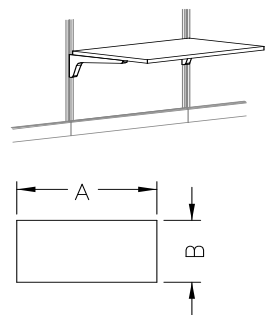

Q1FSERWS.3024L	1.25"	24"	30"	38	\$297
Q1FSERWS.3030L	1.25"	30"	30"	45	\$339
Q1FSERWS.3036L	1.25"	36"	30"	53	\$348
Q1FSERWS.3042L	1.25"	42"	30"	60	\$418
Q1FSERWS.3048L	1.25"	48"	30"	66	\$427
Q1FSERWS.3054L	1.25"	54"	30"	74	\$485
Q1FSERWS.3060L	1.25"	60"	30"	81	\$519
Q1FSERWS.3066L	1.25"	66"	30"	88	\$580
Q1FSERWS.3072L	1.25"	72"	30"	95	\$592

When ordering a worksurface spanning a panel and a 3-Way or Spacer Connector, or two panels with a 3-Way or Space Connector in between the panels, you will need to:

- add 3.5" to the length of the worksurface
- add "-3W" to the part number
- add \$80 to the list price.

Example:
 Two 30" frames with one 3-Way Connector equals to 63.5". In this case, order Q1FSERWS.2460L-3W. (\$414 + \$80 = \$494)

Worksurfaces continued

**SQUARE EDGE
CURVED CORNER**

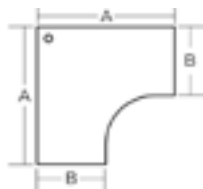
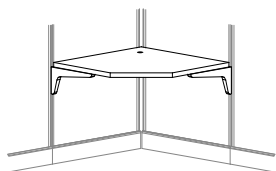

Q1FSECCWS.2436L	1.25"	*36"	24"	54	\$430
Q1FSECCWS.2442L	1.25"	42"	24"	68	\$531
Q1FSECCWS.2448L	1.25"	48"	24"	72	\$563
Q1FSECCWS.3042L	1.25"	*42"	30"	76	\$578
Q1FSECCWS.3048L	1.25"	48"	30"	78	\$609

Includes one wire grommet.

*Keyboard tray may not fit on the 36"W worksurface.

**SQUARE EDGE
HALF CIRCLE**

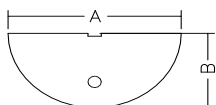
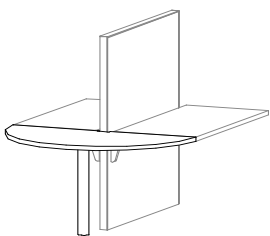

PART #	HEIGHT	WIDTH	DEPTH	WT. (LBS)	LIST
Q1FSEHCWS.50L	29"	52"	26"	55	\$773
Q1FSEHCWS.60L	29"	64"	32"	67	\$872

NOTES

Half Circle Worksurface has a notch and attaches to the end of two back to back rectangular or extended corner worksurfaces.

Includes one support column leg (in DT Dark Tone with a leveling glide) and attachment hardware. Ships knocked down.

**SQUARE EDGE
D-SHAPED PENINSULA**

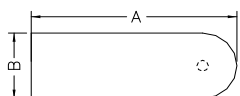
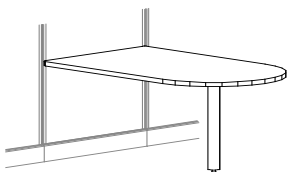

PART #	HEIGHT	WIDTH	DEPTH	WT. (LBS)	LIST
Q1FSEDSP.2448L	29"	48"	24"	62	\$488
Q1FSEDSP.3048L	29"	48"	30"	72	\$534
Q1FSEDSP.2460L	29"	60"	24"	73	\$543
Q1FSEDSP.3060L	29"	60"	30"	87	\$592
Q1FSEDSP.3072L	29"	72"	30"	101	\$647
Q1FSEDSP.3672L	29"	72"	36"	117	\$714

NOTES

Includes one support column leg (in DT Dark Tone with a leveling glide) and attachment hardware. Ships knocked down.

**SQUARE EDGE
RECTANGULAR
TRANSACTION SURFACE**

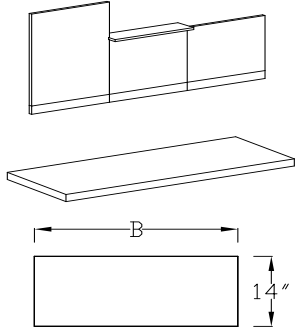

QIFSERTS.1424L	1.25"	14"	24"	17	\$185
QIFSERTS.1430L	1.25"	14"	30"	21	\$218
QIFSERTS.1436L	1.25"	14"	36"	24	\$237
QIFSERTS.1442L	1.25"	14"	42"	27	\$292
QIFSERTS.1448L	1.25"	14"	48"	31	\$297
QIFSERTS.1460L	1.25"	14"	60"	38	\$349
QIFSERTS.1472L	1.25"	14"	72"	43	\$403

Attaches to the top of a panel for counter or display area. Ends are flush with the panel.
Order transaction surface supports separately.

10 DAY WORKSURFACES

**SQUARE EDGE CORNER
TRANSACTION SURFACE**

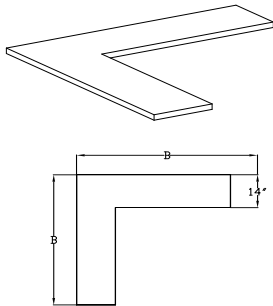

PART #	HEIGHT	WIDTH	DEPTH	WT. (LBS)	LIST
QIFSECTS.24	1.25"	14"	32"	40	\$307
QIFSECTS.30	1.25"	14"	38"	48	\$408
QIFSECTS.36	1.25"	14"	44"	55	\$452
QIFSECTS.42	1.25"	14"	50"	62	\$635
QIFSECTS.48	1.25"	14"	56"	71	\$640

Attaches to the top of two panels sized 24", 30" 36" 42" or 48". Ends are flush with the panel. Panels connected at a 90° angle for corner counter or display area.
Order transaction surface supports separately.

Rectangular My-Hite

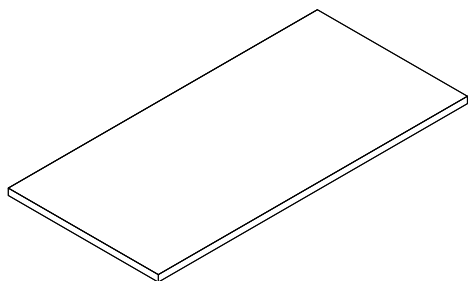

DESCRIPTION

10 day worksurface top only, for use with height adjustable base within workstation application

NOTES

- Add grommet (add \$75 list)
Specify GL, GC, GR
- Order base separately from MY-HITE pricebook

Note: Top size reduced 1" in depth and 2" in width to fit within system workstation and prevent pinch points. We do not recommend using full size worktop in paneled workstation applications.

SPECIFICATION OPTIONS

product #: see charts below
top, edge finish: worksurface finish:
see page 7

ORDER EXAMPLE

product #: Q1FSRWS.2340
edge finish: DT Dark Tone, E12
worksurface finish: Light Maple, M1
grommet: GC (Rear Center)

RECTANGULAR WORKSURFACE

PART #	WIDTH	DEPTH	PRICE
Q1FSRWS.2340	40"	23"	\$307
Q1FSRWS.2346	46"	23"	\$316
Q1FSRWS.2352	52"	23"	\$373
Q1FSRWS.2358	58"	23"	\$383
Q1FSRWS.2364	64"	23"	\$441
Q1FSRWS.2370	70"	23"	\$453
Q1FSRWS.2376	76"	23"	\$553

NOTES

- Sizes are actual for example Q1FSRWS.2364 is 23" x 64"

Q1FSRWS.2940	40"	29"	\$363
Q1FSRWS.2946	46"	29"	\$373
Q1FSRWS.2952	52"	29"	\$442
Q1FSRWS.2958	58"	29"	\$453
Q1FSRWS.2964	64"	29"	\$524
Q1FSRWS.2970	70"	29"	\$537
Q1FSRWS.2976	76"	29"	\$666

Corner My-Hite

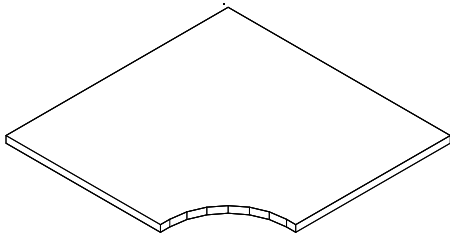

10 day corner worksurface top only, for use with height adjustable base within workstation application

- Add grommet (add \$75 list) Specify GL, GC, GR
- Order base separately from MY-HITE pricebook

Note: Top size reduced 1" in depth and 2" in width to fit within system workstation and prevent pinch points. We do not recommend using full size worktop in paneled workstation applications.

product #: see charts below
top, edge finish: **worksurface finish:** see 7

product #: Q1FSCWS.2340
edge finish: DT Dark Tone, E12
worksurface finish: Light Maple, M1
grommet: GC (Rear Center)

CORNER WORKSURFACE

Q1FSCWS.2340	40"	23"	\$505
Q1FSCWS.2346	46"	23"	\$535
Q1FSCWS.2942	40"	29"	\$698
Q1FSCWS.2948	46"	29"	\$725

- Sizes are actual for example Q1FSCWS.2942 is 29" x 42"

D-Shaped My-Hite

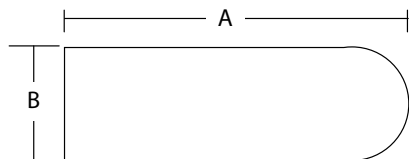

DESCRIPTION

Worksurface D top only, for use with height adjustable base in freestanding application

NOTES

- Add grommet (add \$75 list)
Location is GC
- Order base separately from MY-HITE pricebook

Note: Top size reduced 1" in depth and 2" in width to fit within system workstation and prevent pinch points. We do not recommend using full size worktop in paneled workstation applications.

SPECIFICATION OPTIONS

product #: see charts below
top, edge finish: **worksurface finish:** see page 7

ORDER EXAMPLE

product #: Q1FSEDSP-2346
edge finish: DT Dark Tone, E12
worksurface finish: Espresso, M10
grommet: GC (Rear Center)

D-SHAPED

PART #	HEIGHT	A	B	C	D	PRICE	NOTES
Q1FSEDSP-2346	1.25"	46"	23"	—	—	\$463	• Sizes are actual for example. Q1FSEDSP-2346 is 23" x 46"
Q1FSEDSP-2358	1.25"	58"	23"	—	—	\$516	
Q1FSEDSP-2946	1.25"	46"	29"	—	—	\$507	
Q1FSEDSP-2958	1.25"	58"	29"	—	—	\$562	
Q1FSEDSP-2970	1.25"	70"	29"	—	—	\$615	
Q1FSEDSP-3470	1.25"	70"	35"	—	—	\$677	

Flat Bracket

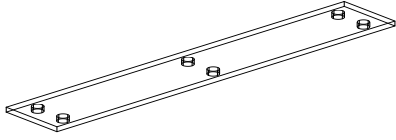

DESCRIPTION

Used to support two worksurfaces when a support leg or panel leg is inappropriate.

NOTES

- Flat bracket finish: Black Umber

SPECIFICATION OPTIONS

product #: see charts below

ORDER EXAMPLE

product #: Q1F2FB.18

Q1F2FB.18	3"	18"	1	\$43
-----------	----	-----	---	------

Supports

DESCRIPTION

Provide support to the worksurface.

SPECIFICATION OPTIONS

product #: see charts below
edge finish: MT Medium Tone, DT Dark Tone
support finish: MT Medium Tone, DT Dark Tone

NOTES

ORDER EXAMPLE

product #: Q1FWSSEP.24-MEL
edge finish: DT Dark Tone
support finish: DT Dark Tone

WORKSURFACE SUPPORT END PANEL

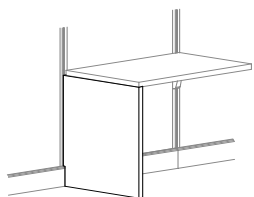

Q1FWSSEP.24-MEL	27.75"	1.25"	24"	26	\$257
Q1FWSSEP.30-MEL	27.75"	1.25"	30"	32	\$296

Non-handed thermally fused laminate panel with 3mm PVC edge supports left or right side of worksurface.
 Available in MT and DT only. (colors may vary slightly from samples)
 Includes leveling glides.
 Includes attachment hardware.

WORKSURFACE SUPPORT P-LEG

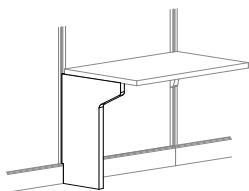

PART #	HEIGHT	WIDTH	DEPTH	WT. (LBS)	LIST
Q1FWSPL.24-MEL	27.75"	1.25"	24"	17	\$257
Q1FWSPL.30-MEL	27.75"	1.25"	30"	20	\$296

Non-handed thermally fused laminate panel with 3mm PVC edge supports left or right side of worksurface.
 Available in MT and DT only. (colors may vary slightly from samples)
 Includes leveling glides.
 Includes attachment hardware.

WORKSURFACE BRACKET

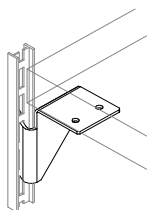

PART #	HEIGHT	WIDTH	DEPTH	WT. (LBS)	LIST
Q1FWSB.L	2.75"	—	2.5"	0.25	\$13
Q1FWSB.R	2.75"	—	2.5"	0.25	\$13

Attaches to the front corner of a hanging worksurface to provide additional support when the return panel matches the worksurface depth.
 Also used as support for the back corner of a corner worksurface.
 Specify left or right.
 Color: Black

Supports continued

TRANSACTION SURFACE SUPPORT END

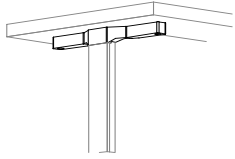

PART #	HEIGHT	WIDTH	DEPTH	WT. (LBS)	PRICE
Q1FTSSE	2.5"	1"	10"	1	\$34

NOTES
Supports the end of a transaction surface, and placed above the last panel in a run.

TRANSACTION SURFACE SUPPORT, MID-END

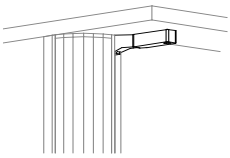

PART #	HEIGHT	WIDTH	DEPTH	WT. (LBS)	PRICE
Q1FTSSM/E	2"	1"	10"	1	\$34

NOTES
Supports a transaction surface in a 180° application.

Placed above a straight-line connector, in a 2-Way 180° connector, or a 2-, 3- or 4-Way 90° connector.

TRANSACTION SURFACE SUPPORT, CENTER

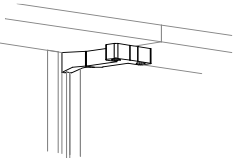

PART #	HEIGHT	WIDTH	DEPTH	WT. (LBS)	PRICE
Q1FTSSC	2"	1"	10"	1	\$35

NOTES
Supports two transaction surfaces in a 180° application.

DUAL COLUMN LEG

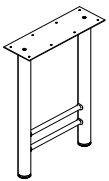

Q1F2DCL	27.75"	18"		25	\$162
---------	--------	-----	--	----	-------

Attaches to the underside of a worksurface.

Has adjustable glides.

Finish: DT Dark Tone.

COLUMN LEG

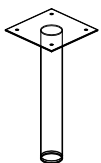

Q1F2CL.4	27.75"	4" Dia	—	16	\$131
----------	--------	--------	---	----	-------

Attaches to the underside of a worksurface.

Has an adjustable glide.

Finish: DT Dark Tone.

10 DAY / WORKSURFACE SUPPORTS

Overheads & Shelves

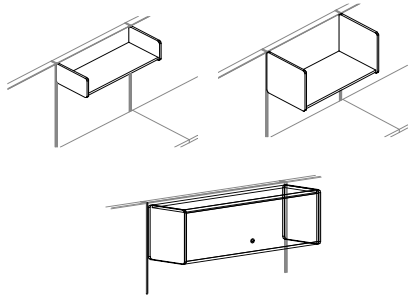

DESCRIPTION

Storage shelves and flipper door units.

SPECIFICATION OPTIONS

product #: see charts below
finish: LG Light Gray, MT Medium Tone, DT Dark Tone

NOTES

- Hangs from panel or wall strips
- Includes attachment hardware
- Metal with paint finish

ORDER EXAMPLE

product #: Q1F2HSH
finish: DT Dark Tone

“B” STYLE SHELF HALF-HEIGHT

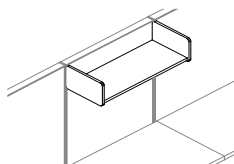

Q1F2HSH.1324	7.5"	24"	12.5"	12	\$149
Q1F2HSH.1330	7.5"	30"	12.5"	13	\$159
Q1F2HSH.1336	7.5"	36"	12.5"	13	\$171
Q1F2HSH.1342	7.5"	42"	12.5"	14	\$183
Q1F2HSH.1348	7.5"	48"	12.5"	15	\$193
Q1F2HSH.1360	7.5"	60"	12.5"	18	\$219

“B” STYLE SHELF FULL HEIGHT

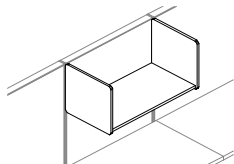

Q1F2FSH.1324	15.5"	24"	12.5"	16	\$179
Q1F2FSH.1330	15.5"	30"	12.5"	17	\$185
Q1F2FSH.1336	15.5"	36"	12.5"	17	\$194
Q1F2FSH.1342	15.5"	42"	12.5"	18	\$206
Q1F2FSH.1348	15.5"	48"	12.5"	19	\$208
Q1F2FSH.1360	15.5"	60"	12.5"	22	\$229

“B” STYLE LOCKING PAINTED FLIPPER UNIT

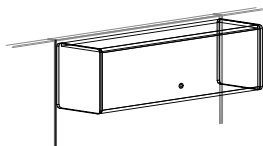

PART #	HEIGHT	WIDTH	DEPTH	WT. (LBS)	LIST	NOTES
Q1F2PFLU.1324	15.5"	24"	12.5"	27	\$361	
Q1F2PFLU.1330	15.5"	30"	12.5"	31	\$387	
Q1F2PFLU.1336	15.5"	36"	12.5"	33	\$430	
Q1F2PFLU.1342	15.5"	42"	12.5"	36	\$449	
Q1F2PFLU.1348	15.5"	48"	12.5"	39	\$480	
Q1F2PFLU.1360	15.5"	60"	12.5"	47	\$586	

Tackboard

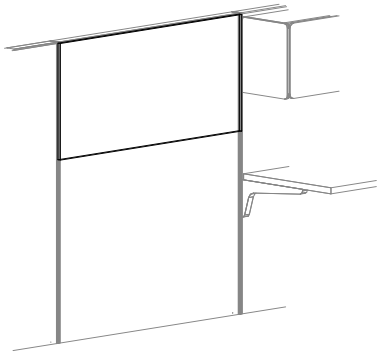

Fabric covered tackable surface.

product #: see charts below
fabric: see page 6

- Attaches to panel or wall strips.
- Includes attachment hardware

product #: Q1F2TAKBS.1624
fabric: Slide-Slate PF101-2

“B” STYLE TACKBOARD SQUARE CORNERS CURVED TOP & BOTTOM 15.5” HIGH

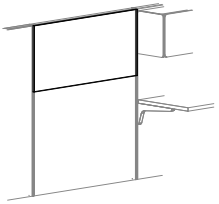

Q1F2TAKBS.1624	15.5"	24"	6	\$169
Q1F2TAKBS.1630	15.5"	30"	7	\$180
Q1F2TAKBS.1636	15.5"	36"	9	\$188
Q1F2TAKBS.1642	15.5"	42"	10	\$196
Q1F2TAKBS.1648	15.5"	48"	11	\$209
Q1F2TAKBS.1660	15.5"	60"	13	\$238

Components

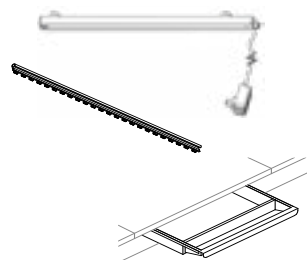

product #: see charts below

product #: Q1FLED.20

LED TASKLIGHT



Q1FLED.20	0.75"	20"	1"	1	\$232
Q1FLED.38	0.75"	38"	1"	2	\$292

Attaches beneath shelf or flipper unit. Includes an LED light, motion sensor, power cord and installation hardware.

Has a pivot range of +/-15°.

For overheads 24"-36" use FLED.20. For overheads 42" or wider use FLED.38.

Finish: Silver

WIRE MANAGER

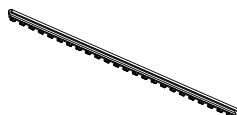

PART #	HEIGHT	WIDTH	DEPTH	WT. (LBS)	LIST
Q1F2WM.24	24"	0.5"	—	2	\$23

NOTES

This wire manager is used to manage electrical cords vertically. It fits between side by side panels or between a panel and a connector.

Finish: Black

PENCIL DRAWER

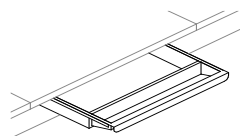

PART #	HEIGHT	WIDTH	DEPTH	WT. (LBS)	LIST
Q1FPD	1.875"	21.125"	16.25	5	\$198

NOTES

Stores small items. Attaches under worksurface.

Finish: MT Medium Tone or DT Dark Tone

Pedestals

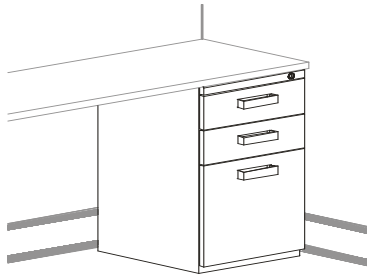

DESCRIPTION

Storage with square drawer front. Metal with paint finish.

SPECIFICATION OPTIONS

product #: see charts below
finish: LG Light Gray, MT Medium Tone, DT Dark Tone
pull: see page 8

NOTES



- Order side-to-side file bars.
- Specify pull when ordering
- Designer Pull has color options: specify color when ordering. See page 8
- Bar Pull will be shipped in box on ALL orders, Premium Pulls will ship separately

ORDER EXAMPLE

product #: Q1FPEDSQP.BBF-MET
finish: DT Dark Tone
pull: Bar

If a cushion is placed on a full height mobile pedestal, it will not fit under a worksurface.

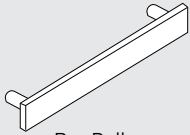
10 DAY / STORAGE & COMPONENTS

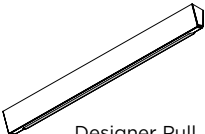
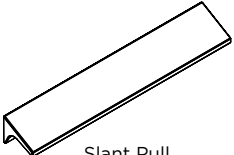
	DEFAULT PULL	PULLS REQUIRING UPCHARGE		
PEDESTAL PULL OPTIONS	 Bar Pull	 Wedge Pull	 Designer Pull • Cloud White/Red • Cloud White/Green • Cloud White/Grey	 Slant Pull

BOX/BOX FILE PEDESTAL

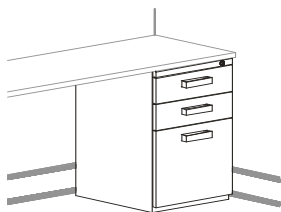

Q1FPEDSQP.BBF-MET	27"	15"	20"	56	\$656
WEDGE, DESIGNER OR SLANT PULL					+ \$75

Supporting metal pedestal with lock, without top cap. Attaches to the underside of a worksurface.
 Specify pull when ordering
 Designer Pull has color options: specify color when ordering. (see page 8)

FILE/FILE PEDESTAL

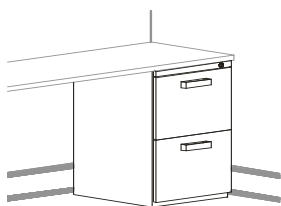

PART #	HEIGHT	WIDTH	DEPTH	WT. (LBS)	LIST
Q1FPEDSQP.FF-MET	27"	15"	20"	53	\$656
WEDGE, DESIGNER OR SLANT PULL					+ \$50

Supporting metal pedestal with lock, without top cap. Attaches to the underside of a worksurface.
 Specify pull when ordering
 Designer Pull has color options: specify color when ordering. (see page 8)

**BOX/BOX/FILE
MOBILE PEDESTAL**

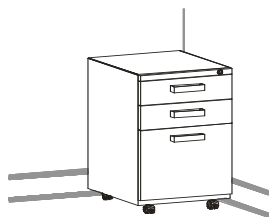

Q1FPEDSQP.BBF-MOB-MET	27.75"	15"	20"	85	\$853
WEDGE, DESIGNER OR SLANT PULL					+ \$75

Freestanding mobile pedestal with lock.
Specify pull when ordering
Designer Pull has color options: specify color when ordering. (see page 8)

If a cushion is placed on a full height mobile pedestal, it will not fit under a worksurface.

**BOX/FILE MOBILE
PEDESTAL**

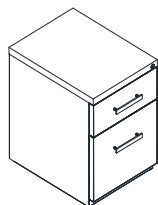

Q1FPEDSQP.BF-MOB-MET	22"	15"	20"	85	\$719
WEDGE, DESIGNER OR SLANT PULL					+ \$50

Freestanding mobile pedestal with lock.
Specify pull when ordering
Designer Pull has color options: specify color when ordering. (see page 8)

If a cushion is placed on a full height mobile pedestal, it will not fit under a worksurface.

**FILE/FILE MOBILE
PEDESTAL**

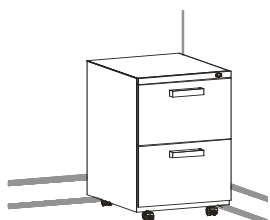

Q1FPEDSQP.FF-MOB-MET	27.75"	15"	20"	76	\$853
WEDGE, DESIGNER OR SLANT PULL					+ \$50

Freestanding mobile pedestal with lock.
Specify pull when ordering
Designer Pull has color options: specify color when ordering. (see page 8)

If a cushion is placed on a full height mobile pedestal, it will not fit under a worksurface.

**SIDE TO SIDE
FILE BAR**

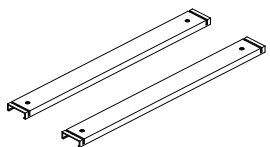

Q1FSSB				1	\$22
--------	--	--	--	---	------

For filing letter or legal size folders.
Order 1 per file drawer.
Black finish only.

Lateral Files

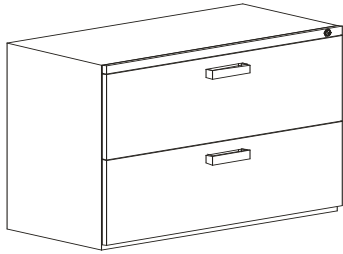



Storage with square drawer front. Metal with paint finish.

product #: see charts below
finish: LG Light Gray, MT Medium Tone, DT Dark Tone
pull: see page 8

- Order front-to-back file bars
- Specify pull when ordering
- Designer Pull has color options: specify color when ordering. See page 8
- Bar Pull will be shipped in box on ALL orders, Premium Pulls will ship separately

product #: Q1FLFSQP-2-30-MET
finish: DT Dark Tone
pull: Wedge, +75 (see upcharge below)

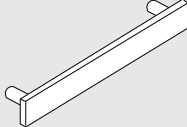
10 DAY / STORAGE & COMPONENTS

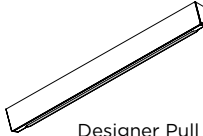
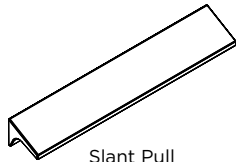
	DEFAULT PULL	PULLS REQUIRING UPCHARGE		
LATERAL PULL OPTIONS	 Bar Pull	 Wedge Pull	 Designer Pull • Cloud White/Red • Cloud White/Green • Cloud White/Grey	 Slant Pull

2 DRAWER LATERAL FILES

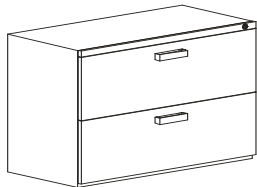

Q1FLFSQP-2-30-MET	27.5"	30"	20	103	\$1,177
Q1FLFSQP-2-36-MET	27.5"	36"	20	123	\$1,428
WEDGE, DESIGNER OR SLANT PULL					+ \$50

Supporting lateral file with lock and finished top cap.

To convert to a freestanding lateral file, order counterweight.

Specify pull when ordering

Designer Pull has color options: specify color when ordering. (see page 8)

FRONT TO BACK FILE BARS

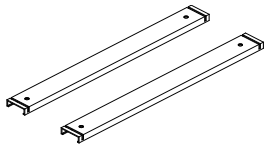

PART #	HEIGHT	WIDTH	DEPTH	WT. (LBS)	LIST
Q1FFB	0.375"	1.1875"	0.6875"	1	\$25

NOTES

Order 1 package of 2 per drawer.
 Black finish only.

LATERAL FILE COUNTERWEIGHT

PART #	HEIGHT	WIDTH	DEPTH	WT. (LBS)	LIST
Q1FLFCW-30	20 lbs counterweight			23	\$66
Q1FLFCW-36	40 lbs counterweight			46	\$99

NOTES

Attaches securely to the inside back of the lateral file.

For 30"W lateral file, use Q1FLFCW-30.

For 36"W lateral file, use Q1FLFCW-36.

For use with 2 drawer lateral files only.

Lateral File Tops Laminate

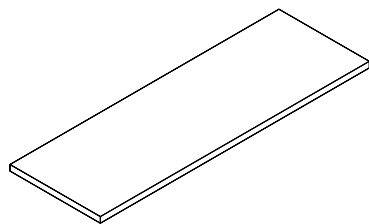

DESCRIPTION

Laminate top for lateral file.

NOTES

- Extended sizes are available, please contact Customer Service for details.

SPECIFICATION OPTIONS

product #: see charts below
finish: see page 7
edge finish: see page 7

ORDER EXAMPLE

product #: FLFSQTOP.2030
finish: M1
edge finish: E1

LATERAL FILE LAMINATE TOPS, 20" DEEP

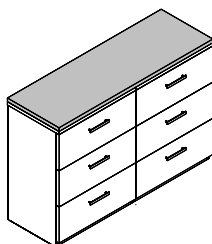

PART #	HEIGHT	WIDTH	DEPTH	PRICE
FLFSQTOP.2030	1.19"	30"	20"	\$235
FLFSQTOP.2036	1.19"	36"	20"	\$275
FLFSQTOP.2042	1.19"	42"	20"	\$301
FLFSQTOP.2060	1.19"	60"	20"	\$504
FLFSQTOP.2066	1.19"	66"	20"	\$520
FLFSQTOP.2072	1.19"	72"	20"	\$536
FLFSQTOP.2078	1.19"	78"	20"	\$562
FLFSQTOP.2084	1.19"	84"	20"	\$589
FLFSQTOP.2090	1.19"	90"	20"	\$641
FLFSQTOP.2096	1.19"	96"	20"	\$818

NOTES

LATERAL FILE LAMINATE TOPS, 40" DEEP

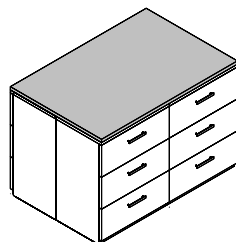

FLFSQTOP.4030	1.19"	30"	40"	\$491
FLFSQTOP.4036	1.19"	36"	40"	\$562
FLFSQTOP.4042	1.19"	42"	40"	\$595
FLFSQTOP.4060	1.19"	60"	40"	\$719
FLFSQTOP.4066	1.19"	66"	40"	\$752
FLFSQTOP.4072	1.19"	72"	40"	\$785
FLFSQTOP.4078	1.19"	78"	40"	\$834
FLFSQTOP.4084	1.19"	84"	40"	\$883
FLFSQTOP.4090	1.19"	90"	40"	\$981
FLFSQTOP.4096	1.19"	96"	40"	\$1,177

Pulls Lateral

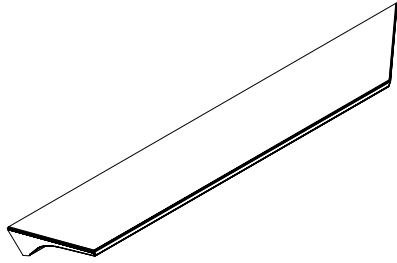

DESCRIPTION

3 different pull options to choose from

NOTES

- Wedge Pull for Lateral
- Designer pull has color options: specify color when ordering. (See chart below)
- Slant Pull for Lateral

SPECIFICATION OPTIONS

product #: see charts below
pull: see charts below

ORDER EXAMPLE

product #: WEDGE-PULL-244
pull: Wedge

10 DAY / STORAGE & COMPONENTS

WEDGE PULL FOR LATERAL

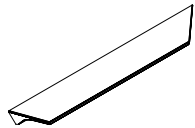

PART #	WT. (LBS)	LIST	NOTES
WEDGE-PULL-244	—	\$25	Wedge Pull for Lateral

DESIGNER PULL FOR LATERAL

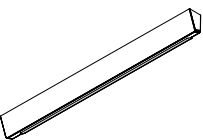

PART #	WT. (LBS)	LIST	NOTES
DESIGNER-PULL-250-RED	—	\$25	Designer Pull is CW (Cloud White) with non-slip color trim on underside. Trim available in 3 colors: Red, Green, and Grey
DESIGNER-PULL-250-GREEN	—	\$25	
DESIGNER-PULL-250-GREY	—	\$25	

SLANT PULL FOR LATERAL

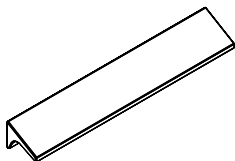

SLANT-PULL-244	—	\$25	Slant Pull for Lateral
----------------	---	------	------------------------

Pulls Pedestal

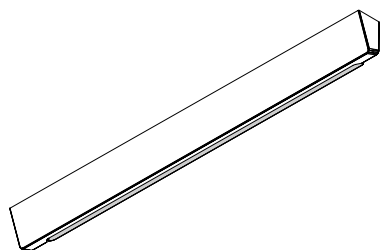

3 different pull options to choose from

product #: see charts below
pull: see charts below

- Wedge Pull for Pedestal
- Designer pull has color options: specify color when ordering. (See chart below)
- Slant Pull for the Pedestal

product #: DESIGNER-PULL-250-RED
pull: Designer Pull, RED

WEDGE PULL FOR PEDESTAL

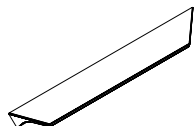

WEDGE-PULL-167

—

\$25

Wedge Pull for Pedestal

DESIGNER PULL FOR PEDESTAL

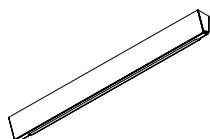

PART #

WT. (LBS)

LIST

NOTES

DESIGNER-PULL-250-RED

—

\$25

Designer Pull is CW (Cloud White) with non-slip color trim on underside. Trim available in 3 colors: Red, Green, and Grey

DESIGNER-PULL-250-GREEN

—

\$25

DESIGNER-PULL-250-GREY

—

\$25

SLANT PULL FOR PEDESTAL

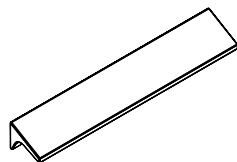

SLANT-PULL-167

—

\$25

Slant Pull for Pedestal

Accessories

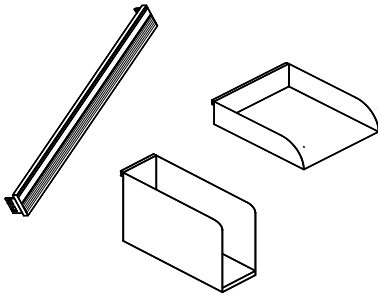

DESCRIPTION

Workstation accessories.

SPECIFICATION OPTIONS

product #: see charts below
finish: LG Light Gray, MT Medium Tone, DT Dark Tone

NOTES

ORDER EXAMPLE

product #: Q1FTB.24
finish: DT Dark Tone

TOOL BARS



Q1FTB.24	3.5"	24"	0.75"	2	\$97
Q1FTB.30	3.5"	30"	0.75"	2	\$103
Q1FTB.36	3.5"	36"	0.75"	3	\$109
Q1FTB.42	3.5"	42"	0.75"	3	\$115
Q1FTB.48	3.5"	48"	0.75"	4	\$122
Q1FTB.60	3.5"	60"	0.75"	5	\$142

Attaches to a panel of same width. Mounting hardware included.

Metal with paint finish.

FLAT PAPER TRAY

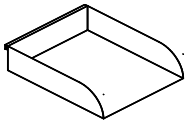

Q1FFPT	3"	10"	12"	2	\$42
--------	----	-----	-----	---	------

VERTICAL SINGLE TRAY

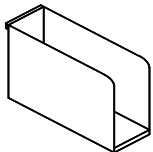

Q1FVST	8"	4"	12"	2	\$40
--------	----	----	-----	---	------

VERTICAL TRIPLE TRAY

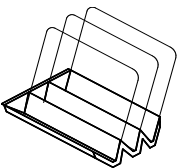

PART #	HEIGHT	WIDTH	DEPTH	WT. (LBS)	LIST
Q1FVTT	11"	12"	12"	4	\$78

NOTES

CARPET GRIPPER



PART #	HEIGHT	WIDTH	DEPTH	WT. (LBS)	LIST
Q1FTCG	—	2.125"	—	0.25	\$5

NOTES

Plastic gripper fits onto the adjustable glides of panel.

Do not use on hardsurface flooring.

Black finish only.

SINGLE MONITOR ARM



FMA-S	—	—	—	—	\$568
-------	---	---	---	---	-------

CW Finish
Includes attachment hardware for clamp, grommet and Verity track mount.

DUAL MONITOR ARM



PART #	HEIGHT	WIDTH	DEPTH	WT. (LBS)	LIST
FMA-D	—	—	—	—	\$811

NOTES
CW Finish
Includes attachment hardware for clamp, grommet and Verity track mount.

Keyed Alike

DESCRIPTION

All Friant pedestals, lateral files and overhead cabinets can be keyed-alike.

SPECIFICATION OPTIONS

product #: see charts below

NOTES

- Keyed-alike cores are sold in sets of 4.
- Each set includes 4 lock cores, each with two keys, all with the same lock #.
- One lock core removal key is shipped with every order.
- Additional lock core removal keys and master keys are also available.

ORDER EXAMPLE

product #: Q1FLCKA

KEYED-ALIKE LOCKS

Q1-KEY-ALIKE-4	Lock Core Keyed-Alike (set of 4)	\$139
Q1-KEY-ALIKE-6	Lock Core Keyed-Alike (set of 6)	\$209
Q1FCK	Lock Core Removal Key	\$21
Q1FMK	Lock Core Master Key	\$21

